



KOLESTON PERFECT ME⁺

CLIENTELE AU DEVENIT MULT MAI PRETENTIOASE

ISI DORESC UN PAR MAI LUNG SI SUNT MULT MAI ATENTE
LA POSIBILELE EFCTE DISTRUCTIVE ASUPRA PARULUI.



SUNT DIN CE IN CE MAI
CONSTIENTE DE INGREDIENTE...

INTERESUL PENTRU INGREDIENTE CHEIE
DE INGRIJIRE A PARULUI.

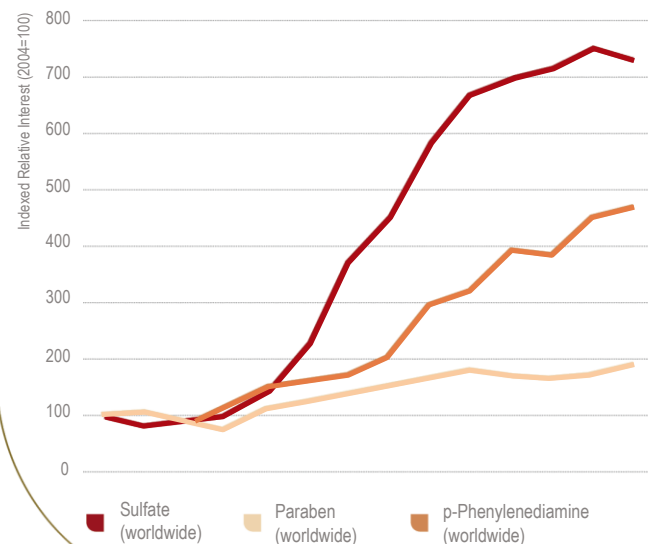

...SI INDIFERENT DE
ISTORIA PARULUI LOR ISI
DORESC CEL MAI BUN
REZULTAT DE CULOARE,
FARA COMPROMISURI.



CONTACTEAZA-NE



WELLA
PROFESSIONALS

CULOAREA CEA MAI PURA

CU TEHNOLOGIA **ME+**

KOLESTON PERFECT SE ADRESEAZA TENDINTELOR GLOBALE,
PENTRU A OFERI O CULOARE PERFECTA SI UN PAR SANATOS.

1 CULOARE



2 INGRIJIRE



3 PREVENIRE



CONTACTEAZA-NE



TEHNOLOGIA PURE BALANCE

CUM FUNCTIONEAZA

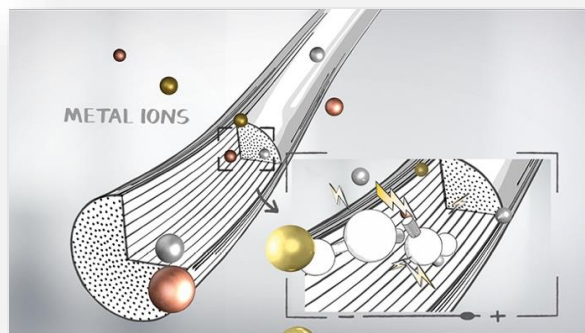

1 METALELE SUNT PREZENTE IN PAR...

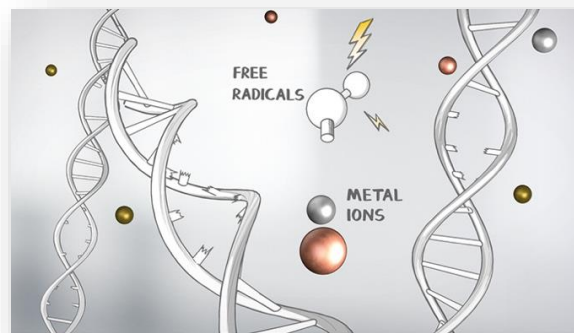

2 POT AFECTA LEGATURILE DIN FIRUL DE PAR

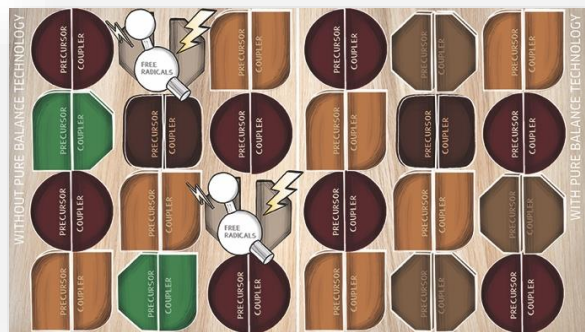

3 POT AFECTA FORMAREA CULORII

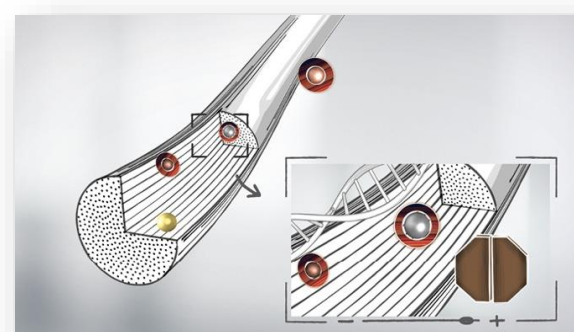

4 TEHNOLOGIA PURE BALANCE

CONTACTEAZA-NE



TEHNOLOGIA ME⁺

PANA LA 60X MAI PUTIN PROBABIL PENTRU CLIENTA SA DEZVOLTE ALERGIE LA COLORARE.

WELLA PROFESSIONALS ANTICIPEAZA NEVOIA SI PROTEJEAZA CLIENTELE.



CONTACTEAZA-NE



IL FOLOSESTI LA FEL... SI IN PLUS TE BUCURI DE MULTE IMBUNATATIRI 😊

AMESTECARE MAI USOARA



APLICARE MAI PRECISA



PARFUM IMBUNATATIT



ACELEASI PROPORȚII
DE AMESTEC



CONTACTEAZA-NE



IL FOLOSESTI LA FEL... SI IN PLUS TE BUCURI DE MULTE IMBUNATATIRI 😊

PROPORTIA DE AMESTEC +



TIMP DE ACTIONARE +

+ CU CALDURA 15-25 min

- FARA CALDURA 30-40 min

+ CU CALDURA 25-35 min

- FARA CALDURA 50-60 min

ACOPERIREA +

PANA LA **100%** ACOPERIREA PARULUI ALB

UTILIZAREA +

APLICARE

Tot parul / partial / creativ



DESCHIDERE/
INCHIDERE /

TON PE TON



GLOSSING



CORECTIA
CULORII



IMPROSPATAREA/
ECHILIBREA

CULORII



CONTACTEAZA-NE



SASE FAMILII DE NUANTE



**PURE
NATURALS**



**RICH
NATURALS**



**VIBRANT
REDS**



**DEEP
BROWNS**



**SPECIAL
BLONDE**



**SPECIAL
MIX**

CONTACTEAZA-NE





PURE NATURALS



RICH NATURALS



DEEP BROWNS



VIBRANT REDS

DEPTH	PURE		RESISTANT COVER	ULTRA	COOL		WARM	
	X/0	XX/0	/00	/01	/03	/04	/07	
10/	10/0				10/03	10/04		
9/	9/0	99/0	9/00	9/01	9/03	9/04		
8/	8/0	88/0	8/00	8/01	8/03	8/04	8/07	
7/	7/0	77/0	7/00	7/01	7/03	7/07		
6/	6/0	66/0	6/00			6/07		
5/	5/0	55/0	5/00			5/07		
4/	4/0	44/0	4/00			4/07		
3/	3/0	33/0	3/00					
2/	2/0							

COOL				WARM			COOL							
/1	/16	/17	/18	/2	/3	/31	/37	/38	/8	/81	/86	/95	/96	/97
10/1	10/16				10/3	10/31		10/38	10/8	9/81	10/86	10/95	10/96	10/97
9/1	9/16	9/17			9/3	9/31		9/38	9/8			9/95	9/97	
8/1			8/2	8/3				8/38				8/95	8/97	
7/1	7/17	7/18			7/3	7/31	7/37	7/38						
6/1			6/2	6/3										6/97
5/1			5/2	5/3		5/37								
														2/8

WARM	COOL	WARM	COOL	WARM	
/7	/71	/73	/74	/75	/77
9/7		9/73			
8/7	8/71	8/73	8/74		
7/7	7/71	7/73	7/75	7/77	
6/7	6/71	6/73	6/74	6/75	6/77
5/7	5/73		5/75	5/77	
4/7			4/75	4/77	

WARM	COOL	WARM		COOL	WARM	COOL						
/34	/41	/43	XX/43	XX/44	/45	XX/46	/47	/5	XX/55	/56	XX/65	XX/66
8/34	8/41	8/43	88/43		8/45						66/56	
7/34		7/43	77/43	77/44	7/45	77/46						
6/34	6/41	6/43	66/44	6/45	66/46						55/56	55/66
	5/41		55/44	55/46				5/5	55/55		55/65	55/66
									44/55		44/65	44/66
											33/55	33/66



SPECIAL BLONDE



SPECIAL MIX

KOLESTON PERFECT^{ME}

NATURAL			WARM			COOL					
/0	/03	/07	/1	/11	/16	/22	/61	/81	/89	/96	
12/0	12/03	12/07	12/1	12/11	12/16	12/22	12/61	12/81	12/89	12/96	

CLEAR	COOL		WARM				COOL		
/00	/11	/28	/30	/33	/43	/44	/65	/66	/88
0/00	0/11	0/28	0/30	0/33	0/43	0/44	0/65	0/66	0/88

DESCARCA APLICATIA



App Store



Google Play

CONTACTEAZA-NE



WELLOXON PERFECT

» USOR SI REPEDE DE
AMESTECAT

» APLICARE PRECISA

» ADERA BINE
PRODUSUL PE FOLIE

» USOR DE LIMPEZIT



CONTACTEAZA-NE





DEMO MIX, SMELL & SEE

CONTACTEAZA-NE



INSPIRA-TI CLIENTELE! COLECTIILE DE NUANTE



CONTACTEAZA-NE



PURE BEIGE COLLECTION

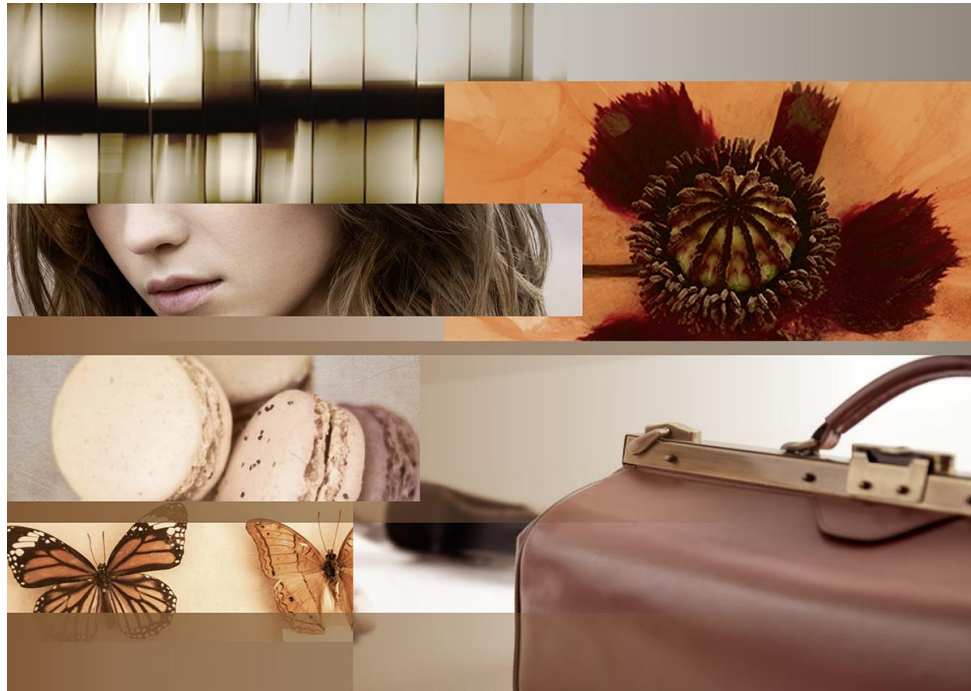

5 SUMPTOUS BEIGE SHADES



HINTING DARKS COLLECTION

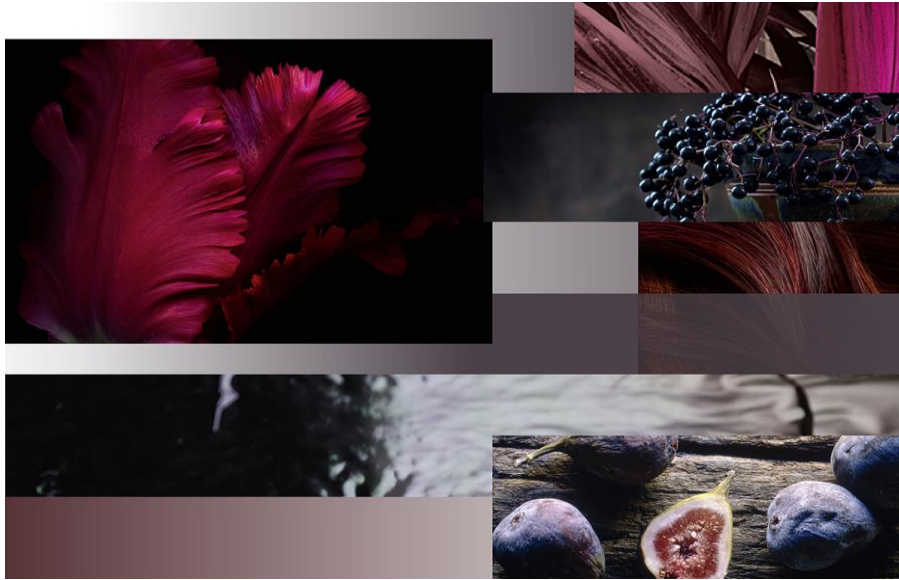

4 INDULGENT DARK SHADES



1 WARMTH ENHANCER



FROSTED BLONDES COLLECTION



MUTED REDS COLLECTION



3 CORE SOFT WARM SHADES



1 INTENSIFIER (FOR COOLNESS)



1 PIGMENT DILUTER



NEW



STONEWARE COLLECTION



1 COOL ENHANCER

8/2

NEW

4 COOL URBAN SHADES

10/95

9/81

7/17

7/18



RASFATA-TI CLIENTELE! SERVICII NOI DE COLORARE

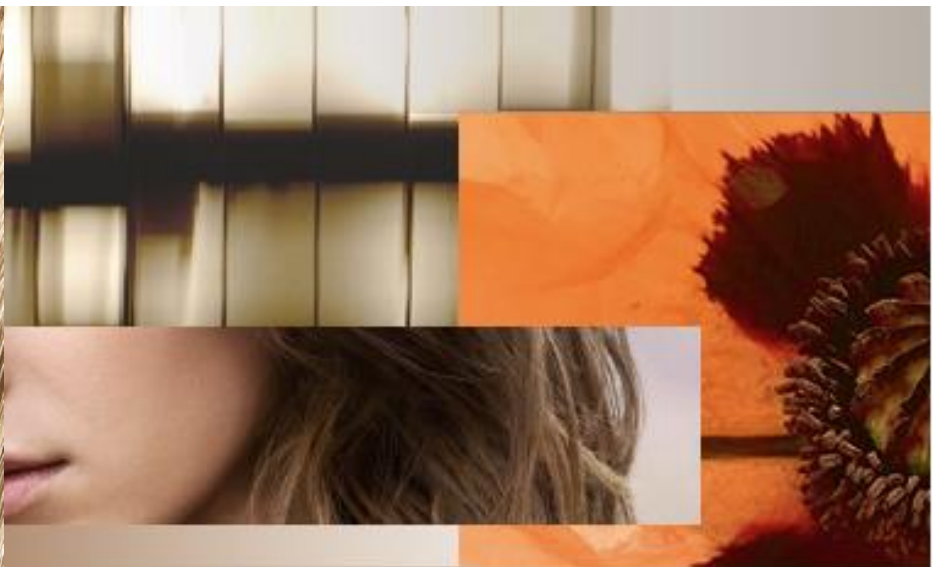

CONTACTEAZA-NE



PURE GLOSSING

Un serviciu rapid pentru a infuza culoarea cu luciu radiant intre vopsiri sau pentru a mentine rezultatul perfect de culoare .



TIMP DE ACTIONARE



- FARA CALDURA: 5-10 min



CONTACTEAZA-NE



WELLA
PROFESSIONALS

PURE SOFT BALANCE

Pentru a oferi un aport suplimentar de culoare si luciu si pentru a obtine un efect de par proaspat colorat la fiecare vizita.

» Dupa timpul de actionare udati parul cu apa si emulsionati culoarea pe lungimi si varfuri.

TIMP DE ACTIONARE

 - FARA CALDURA: 5-10 min



CONTACTEAZA-NE



WELLA
PROFESSIONALS

PURE INTENSE BALANCE

Reimprospatarea culorii pentru un efect pur si uniform,
de lunga durata, pe varfuri matuite.



TIMP DE ACTIONARE

 - FARA CALDURA: 5-10 min



CONTACTEAZA-NE



WELLA
PROFESSIONALS

PURE REBUILD BALANCE

Un serviciu cu WELLAPLEX pentru a reimprospata lungimile si varfurile dandu-l totodata un aspect mai puternic si mai sanatos.



» Limpeziti si indepartati amestecul aplicat. Aplicati WELLAPLEX No. 2, pentru 10 min.

TIMP DE ACTIONARE

 - FARA CALDURA: 5-10 min



CONTACTEAZA-NE



WELLA
PROFESSIONALS



URMARESTI-NE



CONTEACTEAZA-NE

